**Identification cards — Contactless
integrated circuit(s) cards — Vicinity
cards —**

Part 2:
Air interface and initialization

*Cartes d'identification — Cartes à circuit(s) intégré(s) sans contact —
Cartes de voisinage —*

Partie 2: Interface et initialisation dans l'air

Reference number
ISO/IEC 15693-2:2000(E)



© ISO/IEC 2000

PDF disclaimer

This PDF file may contain embedded typefaces. In accordance with Adobe's licensing policy, this file may be printed or viewed but shall not be edited unless the typefaces which are embedded are licensed to and installed on the computer performing the editing. In downloading this file, parties accept therein the responsibility of not infringing Adobe's licensing policy. The ISO Central Secretariat accepts no liability in this area.

Adobe is a trademark of Adobe Systems Incorporated.

Details of the software products used to create this PDF file can be found in the General Info relative to the file; the PDF-creation parameters were optimized for printing. Every care has been taken to ensure that the file is suitable for use by ISO member bodies. In the unlikely event that a problem relating to it is found, please inform the Central Secretariat at the address given below.

© ISO/IEC 2000

All rights reserved. Unless otherwise specified, no part of this publication may be reproduced or utilized in any form or by any means, electronic or mechanical, including photocopying and microfilm, without permission in writing from either ISO at the address below or ISO's member body in the country of the requester.

ISO copyright office
Case postale 56 • CH-1211 Geneva 20
Tel. + 41 22 749 01 11
Fax + 41 22 734 10 79
E-mail copyright@iso.ch
Web www.iso.ch

Printed in Switzerland

Contents

Page

1 Scope	1
2 Normative reference	1
3 Terms and definitions	1
4 Symbols and abbreviated terms	2
4.1 Abbreviations	2
4.2 Symbols	2
5 Initial dialogue for vicinity cards	2
6 Power transfer	3
6.1 Frequency.....	3
6.2 Operating field.....	3
7 Communications signal interface VCD to VICC	3
7.1 Modulation.....	3
7.2 Data rate and data coding	5
7.2.1 Data coding mode: 1 out of 256	5
7.2.2 Data coding mode: 1 out of 4	6
7.3 VCD to VICC frames	7
7.3.1 SOF to select 1 out of 256 code	7
7.3.2 SOF to select 1 out of 4 code	7
7.3.3 EOF for either data coding mode	7
8 Communications signal interface VICC to VCD	8
8.1 Load modulation.....	8
8.2 Subcarrier	8
8.3 Data rates.....	8
8.4 Bit representation and coding	8
8.4.1 Bit coding when using one subcarrier	8
8.4.2 Bit coding when using two subcarriers	9
8.5 VICC to VCD frames	10
8.5.1 SOF when using one subcarrier.....	10
8.5.2 SOF when using two subcarriers.....	11
8.5.3 EOF when using one subcarrier.....	11
8.5.4 EOF when using two subcarriers.....	11
Annex A (informative) Standards compatibility	13

Foreword

ISO (the International Organization for Standardization) and IEC (the International Electrotechnical Commission) form the specialized system for worldwide standardization. National bodies that are members of ISO or IEC participate in the development of International Standards through technical committees established by the respective organization to deal with particular fields of technical activity. ISO and IEC technical committees collaborate in fields of mutual interest. Other international organizations, governmental and non-governmental, in liaison with ISO and IEC, also take part in the work.

International Standards are drafted in accordance with the rules given in the ISO/IEC Directives, Part 3.

In the field of information technology, ISO and IEC have established a joint technical committee, ISO/IEC JTC 1. Draft International Standards adopted by the joint technical committee are circulated to national bodies for voting. Publication as an International Standard requires approval by at least 75 % of the national bodies casting a vote.

Attention is drawn to the possibility that some of the elements of this part of ISO/IEC 15693 may be the subject of patent rights. ISO and IEC shall not be held responsible for identifying any or all such patent rights.

International Standard ISO/IEC 15693-2 was prepared by Joint Technical Committee ISO/IEC JTC 1, *Information technology*, Subcommittee SC 17, *Identification cards and related devices*.

ISO/IEC 15693 consists of the following parts, under the general title *Identification cards — Contactless integrated circuit(s) cards — Vicinity cards*:

- *Part 1: Physical characteristics*
- *Part 2: Air interface and initialization*
- *Part 3: Anticollision and transmission protocol*
- *Part 4: Extended command set and security features*

Annex A of this part of ISO/IEC 15693 is for information only.

Introduction

ISO/IEC 15693 is one of a series of International Standards describing the parameters for identification cards as defined in ISO/IEC 7810 and the use of such cards for international interchange.

This part of ISO/IEC 15693 describes the electrical characteristics of the contactless interface between a vicinity card and a vicinity coupling device. The interface includes power and bi-directional communications.

This part of ISO/IEC 15693 does not preclude the incorporation of other standard technologies on the card.

Contactless card standards cover a variety of types as embodied in ISO/IEC 10536 (Close-coupled cards), ISO/IEC 14443 (Proximity cards), ISO/IEC 15693 (Vicinity cards). These are intended for operation when very near, nearby and at a longer distance from associated coupling devices respectively.

The International Organization for Standardization (ISO) and International Electrotechnical Commission (IEC) draw attention to the fact that it is claimed that compliance with this part of ISO/IEC 15693 may involve the use of patents.

ISO and IEC take no position concerning the evidence, validity and scope of these patent rights.

The holders of these patent rights have assured ISO and IEC that they are willing to negotiate licences under reasonable and non-discriminatory terms and conditions with applicants throughout the world. In this respect, the statements of the holders of patent rights are registered with the ISO and IEC. Information may be obtained from:

Subclause 7.2 Data rate and data coding

*Infineon Technologies AG
P O Box 800949
D-81609 Munich
Germany*

*Koninklijke Philips Electronics N.V.
Prof. Holstlaan 6
6566 AA Eindhoven
The Netherlands*

*Omron Corporation
Intellectual Property Group
20 Igadera, Shimokaiinji,
Nagaokakyo-City
Kyoto, 617-8510 Japan*

Subclause 8.2 Subcarrier
Subclause 8.3 Data rates

*Texas Instruments
Deutschland GmbH
D-85350 Freising
Germany*

Attention is drawn to the possibility that some of the elements of this part of ISO/IEC 15693 may be the subject of patent rights other than those identified above. ISO and IEC shall not be held responsible for identifying any or all such patent rights.

Identification cards — Contactless integrated circuit(s) cards — Vicinity cards —

Part 2: Air interface and initialization

1 Scope

This part of ISO/IEC 15693 specifies the nature and characteristics of the fields to be provided for power and bi-directional communications between vicinity coupling devices (VCDs) and vicinity cards (VICCs).

This part of ISO/IEC 15693 shall be used in conjunction with other parts of ISO/IEC 15693.

This part of ISO/IEC 15693 does not specify the means of generating coupling fields, nor the means of compliance with electromagnetic radiation and human exposure regulations which can vary according to country regulations and/or standards.

2 Normative reference

The following normative document contains provisions which, through reference in this text, constitute provisions of this part of ISO/IEC 15693. For dated references, subsequent amendments to, or revision of, any of these publications do not apply. However, parties to agreements based on this part of ISO/IEC 15693 are encouraged to investigate the possibility of applying the most recent edition of the normative document indicated below. For undated references, the latest edition of the normative document referred to applies. Members of ISO and IEC maintain registers of currently valid International Standards.

ISO/IEC 10373-7:—¹⁾, *Identification cards — Test methods — Vicinity cards*.

3 Terms and definitions

For the purposes of this part of ISO/IEC 15693, the terms and definitions given in ISO/IEC 15693-1 and the following apply.

3.1 modulation index

index equal to $[a-b]/[a+b]$ where a and b are the peak and minimum signal amplitude respectively.

NOTE The value of the index may be expressed as a percentage.

3.2 subcarrier

a signal of frequency f_s used to modulate the carrier of frequency f_c

¹⁾ To be published.

3.3

byte

a byte consists of 8 bits of data designated b1 to b8, from the most significant bit (MSB,b8) to the least significant bit (LSB,b1)

4 Symbols and abbreviated terms

For the purposes of this part of ISO/IEC 15693, the following abbreviations and symbols apply.

4.1 Abbreviations

ASK	Amplitude shift keying
EOF	End of frame
LSB	Least significant bit
MSB	Most significant bit
PPM	Pulse position modulation
RF	Radio frequency
SOF	Start of frame
VCD	Vicinity coupling device
VICC	Vicinity integrated circuit card

4.2 Symbols

a	Carrier amplitude without modulation
b	Carrier amplitude when modulated
f_c	Frequency of operating field (carrier frequency)
f_s	Frequency of subcarrier
H_{max}	Maximum operating field
H_{min}	Minimum operating field

5 Initial dialogue for vicinity cards

The dialogue between the VCD and the VICC (one or more VICCs may be present at the same time) is conducted through the following consecutive operations:

- activation of the VICC by the RF operating field of the VCD,
- VICC waits silently for a command from the VCD,
- transmission of a command by the VCD,
- transmission of a response by the VICC.

These operations use the RF power transfer and communication signal interface specified in the following paragraphs and shall be performed according to the protocol defined in ISO/IEC 15693-3.

6 Power transfer

Power transfer to the VICC is accomplished by radio frequency via coupling antennas in the VCD and in the VICC. The RF operating field that supplies power to the VICC from the VCD is modulated for communication from the VCD to the VICC, as described in clause 7.

6.1 Frequency

The frequency f_c of the RF operating field is 13,56 MHz \pm 7 kHz. Operating field

6.2 Operating field

A VICC shall operate as intended continuously between H_{\min} and H_{\max} .

The minimum operating field is H_{\min} and has a value of 150 mA/m rms.

The maximum operating field is H_{\max} and has a value of 5 A/m rms.

A VCD shall generate a field of at least H_{\min} and not exceeding H_{\max} at manufacturer's specified positions (operating volume).

In addition, the VCD shall be capable of powering any single reference VICC (defined in the test methods) at manufacturer's specified positions (within the operating volume).

The VCD shall not generate a field higher than the value specified in ISO/IEC 15693-1 (alternating magnetic field) in any possible VICC position.

Test methods for determining the VCD operating field are defined in ISO/IEC 10373-7.

7 Communications signal interface VCD to VICC

For some parameters several modes have been defined in order to meet different international radio regulations and different application requirements.

From the modes specified any data coding can be combined with any modulation.

7.1 Modulation

Communications between the VCD and the VICC takes place using the modulation principle of ASK. Two modulation indexes are used, 10% and 100%. The VICC shall decode both. The VCD determines which index is used.

Depending on the choice made by the VCD, a "pause" will be created as described in Figure 1 and Figure 2.

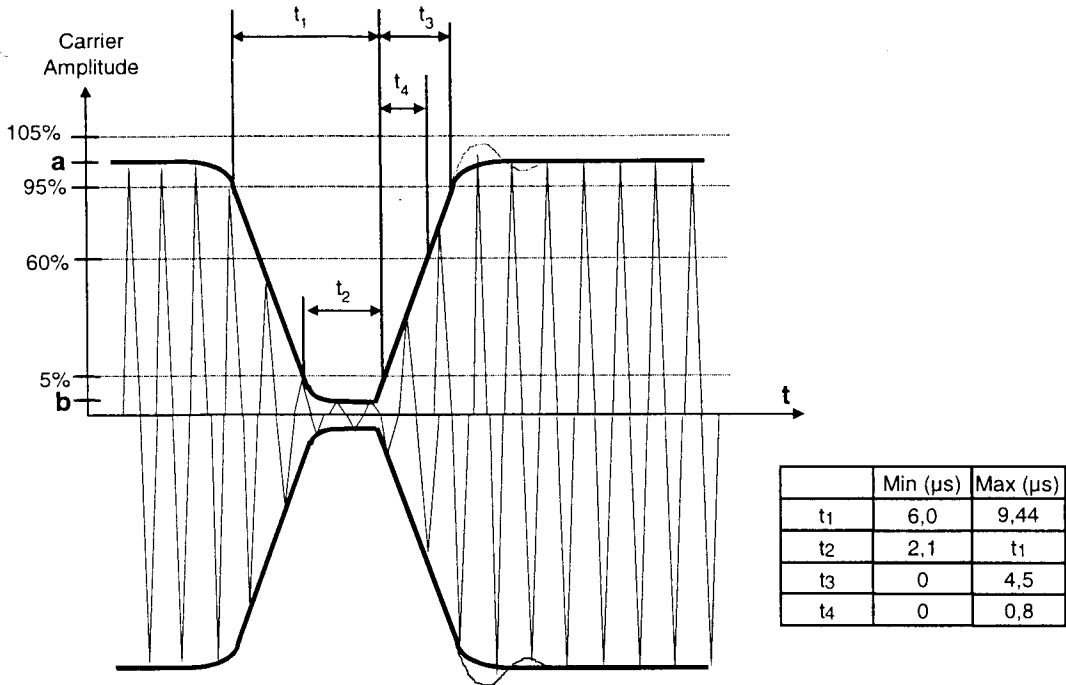

The clock recovery must be operational after t_4 max

Figure 1 — Modulation of the carrier for 100% ASK

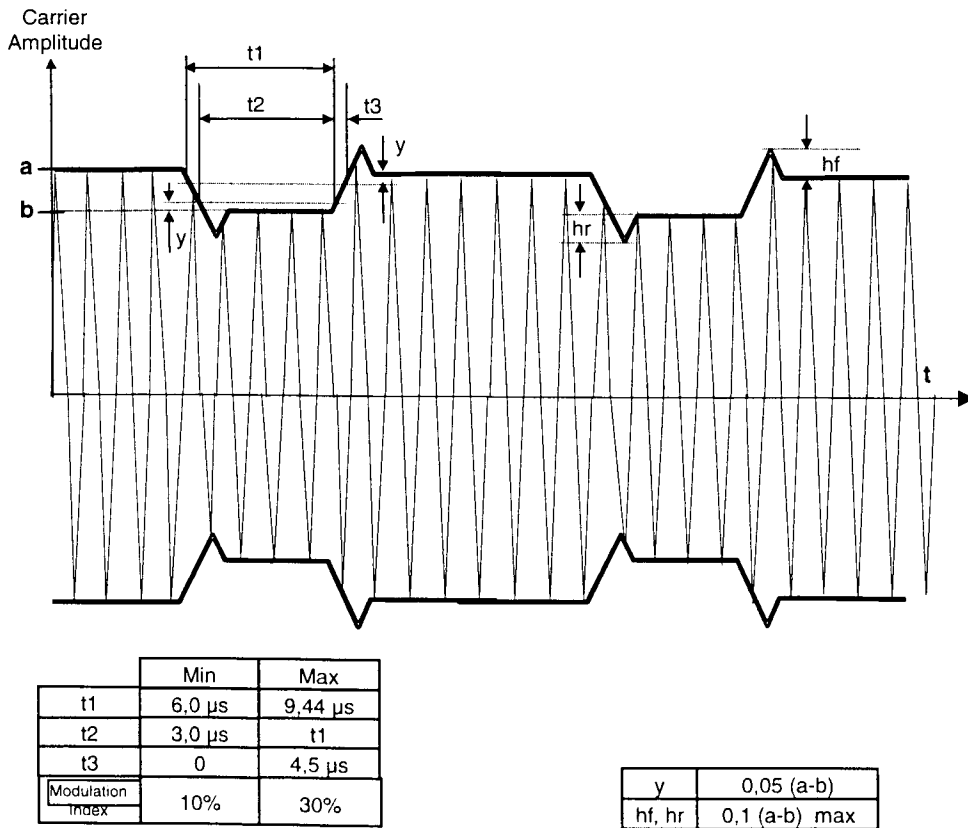

The VICC shall be operational for any value of modulation index between 10% and 30%.

Figure 2 — Modulation of the carrier for 10% ASK

7.2 Data rate and data coding

Data coding shall be implemented using pulse position modulation.

Two data coding modes shall be supported by the VICC. The selection shall be made by the VCD and indicated to the VICC within the start of frame (SOF), as defined in 7.3.

7.2.1 Data coding mode: 1 out of 256

The value of one single byte shall be represented by the position of one pause. The position of the pause on 1 of 256 successive time periods of $256/f_c$ ($\sim 18,88 \mu s$), determines the value of the byte. In this case the transmission of one byte takes $\sim 4,833 ms$ and the resulting data rate is $1,65 kbits/s$ ($f_c/8192$). The last byte of the frame shall be completely transmitted before the EOF is sent by the VCD.

Figure 3 illustrates this pulse position modulation technique.

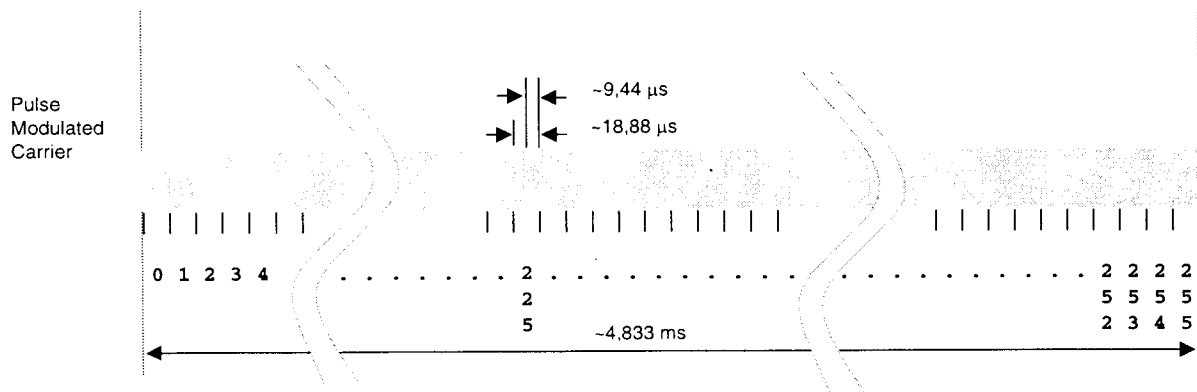

Figure 3 — 1 out of 256 coding mode

In Figure 3 data 'E1' = $(11100001)_b = (225)$ is sent by the VCD to the VICC.

The pause shall occur during the second half of the position of the time period that determines the value, as shown in Figure 4.

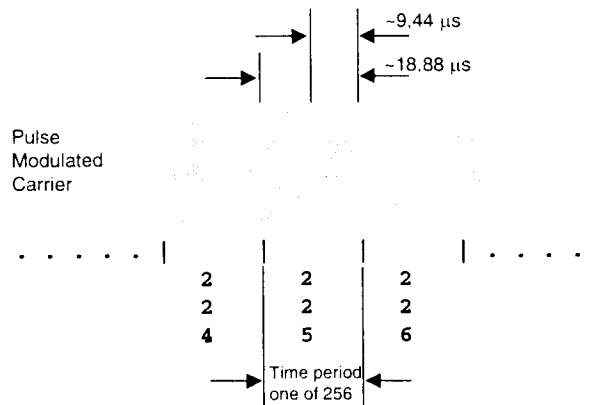

Figure 4 — Detail of one time period

7.2.2 Data coding mode: 1 out of 4

Pulse position modulation for 1 out of 4 mode shall be used, in this case the position determines two bits at a time. Four successive pairs of bits form a byte, where the least significant pair of bits is transmitted first.

The resulting data rate is 26,48 kbits/s ($f_c/512$).

Figure 5 illustrates the 1 out of 4 pulse position technique and coding.

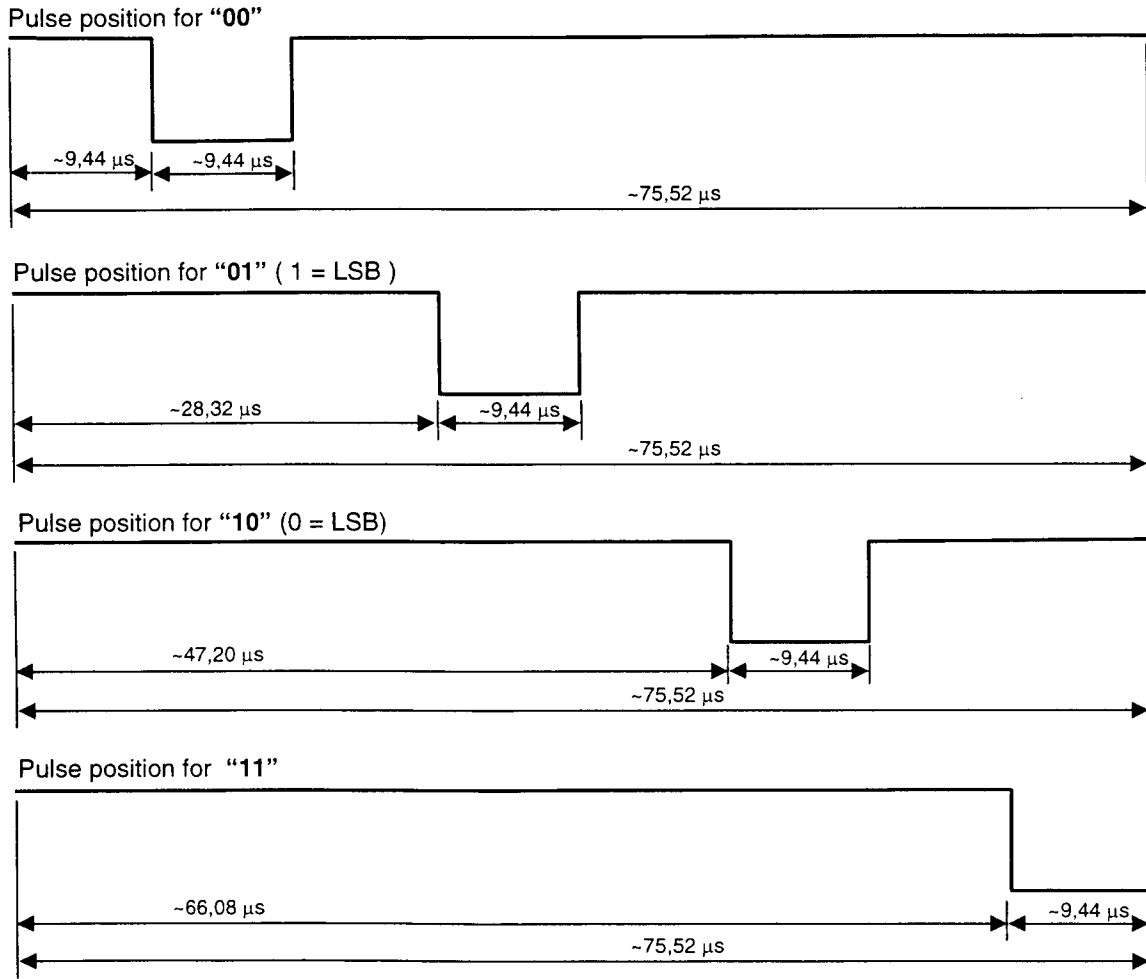

Figure 5 — 1 out of 4 coding mode

For example Figure 6 shows the transmission of 'E1' = (11100001)_b = 225 by the VCD.

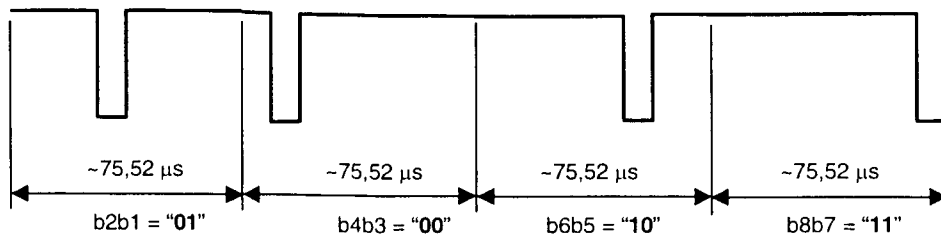

Figure 6 — 1 out of 4 coding example

7.3 VCD to VICC frames

Framing has been chosen for ease of synchronization and independence of protocol.

Frames shall be delimited by a start of frame (SOF) and an end of frame (EOF) and are implemented using code violation. Unused options are reserved for future use by ISO/IEC.

The VICC shall be ready to receive a frame from the VCD within 300 μs after having sent a frame to the VCD.

The VICC shall be ready to receive a frame within 1 ms of activation by the powering field.

7.3.1 SOF to select 1 out of 256 code

The SOF sequence described in Figure 7 selects the 1 out of 256 data coding mode.

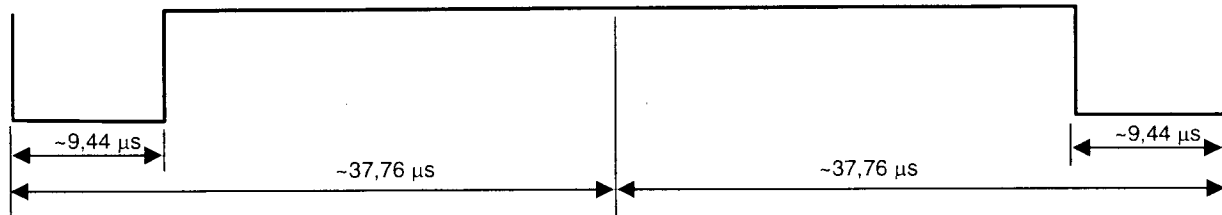

Figure 7 — Start of frame of the 1 out of 256 mode

7.3.2 SOF to select 1 out of 4 code

The SOF sequence described in Figure 8 selects the 1 out of 4 data coding mode.

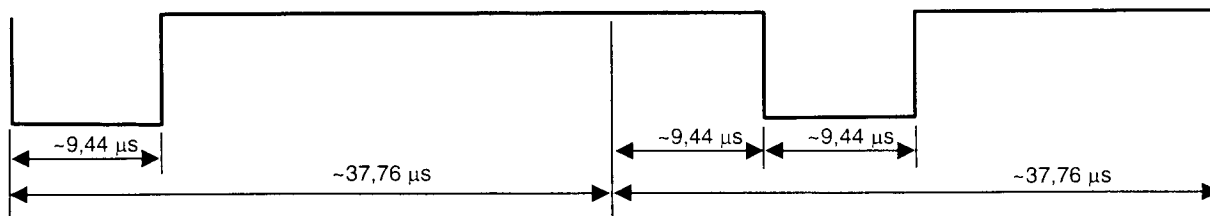

Figure 8 — Start of frame of the 1 out of 4 mode

7.3.3 EOF for either data coding mode

The EOF sequence for either coding mode is described in Figure 9.

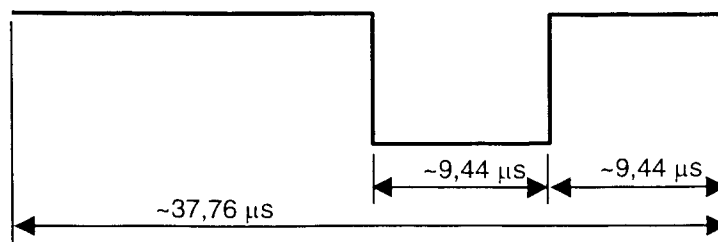

Figure 9 — End of frame for either mode

8 Communications signal interface VICC to VCD

For some parameters several modes have been defined in order to allow for use in different noise environments and application requirements.

8.1 Load modulation

The VICC shall be capable of communication to the VCD via an inductive coupling area whereby the carrier is loaded to generate a subcarrier with frequency f_s . The subcarrier shall be generated by switching a load in the VICC.

The load modulation amplitude shall be at least 10 mV when measured as described in the test methods.

Test methods for VICC load modulation are defined in International Standard ISO/IEC 10373-7.

8.2 Subcarrier

One or two subcarriers may be used as selected by the VCD using the first bit in the protocol header as defined in ISO/IEC 15693-3. The VICC shall support both modes.

When one subcarrier is used, the frequency f_{s1} of the subcarrier load modulation shall be $f_c/32$ (423,75 kHz).

When two subcarriers are used, the frequency f_{s1} shall be $f_c/32$ (423,75 kHz), and the frequency f_{s2} shall be $f_c/28$ (484,28 kHz).

If two subcarriers are present there shall be a continuous phase relationship between them.

8.3 Data rates

A low or high data rate may be used. The selection of the data rate shall be made by the VCD using the second bit in the protocol header as defined in ISO/IEC 15693-3. The VICC shall support the data rates shown in table 1.

Table 1 — Data rates

Data Rate	Single Subcarrier	Dual Subcarrier
Low	6,62 kbits/s ($f_c/2048$)	6,67 kbits/s ($f_c/2032$)
High	26,48 kbits/s ($f_c/512$)	26,69 kbits/s ($f_c/508$)

8.4 Bit representation and coding

Data shall be encoded using Manchester coding, according to the following schemes. All timings shown refer to the high data rate from the VICC to the VCD. For the low data rate the same subcarrier frequency or frequencies are used, in this case the number of pulses and the timing shall be multiplied by 4.

8.4.1 Bit coding when using one subcarrier

A logic 0 starts with 8 pulses of $f_c/32$ (~423,75 kHz) followed by an unmodulated time of $256/f_c$ (~18,88 μ s), see Figure 10.

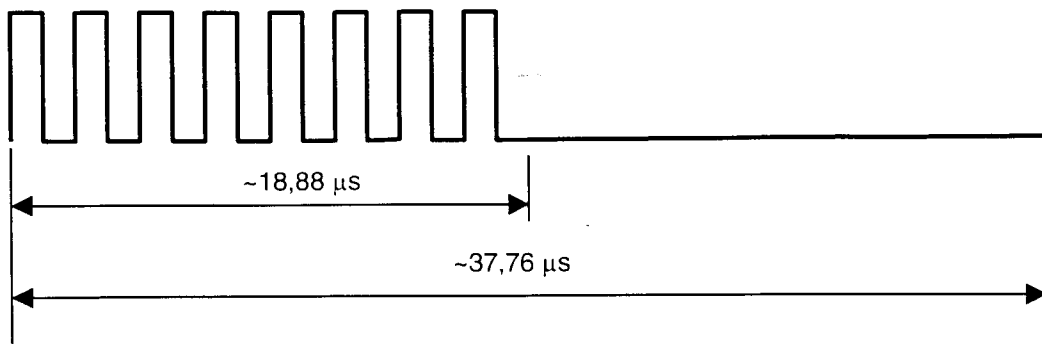

Figure 10 — Logic 0

A logic 1 starts with an unmodulated time of $256/f_c$ ($\sim 18,88 \mu\text{s}$) followed by 8 pulses of $f_c/32$ ($\sim 423,75 \text{ kHz}$), see Figure 11.

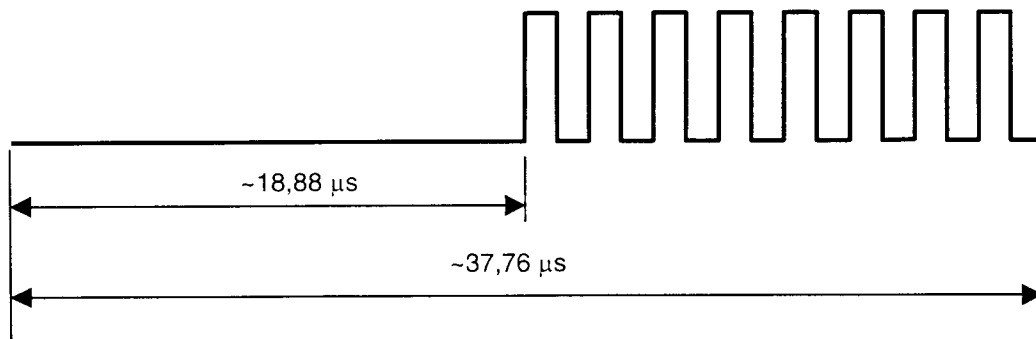

Figure 11 — Logic 1

8.4.2 Bit coding when using two subcarriers

A logic 0 starts with 8 pulses of $f_c/32$ ($\sim 423,75 \text{ kHz}$) followed by 9 pulses of $f_c/28$ ($\sim 484,28 \text{ kHz}$), see Figure 12.

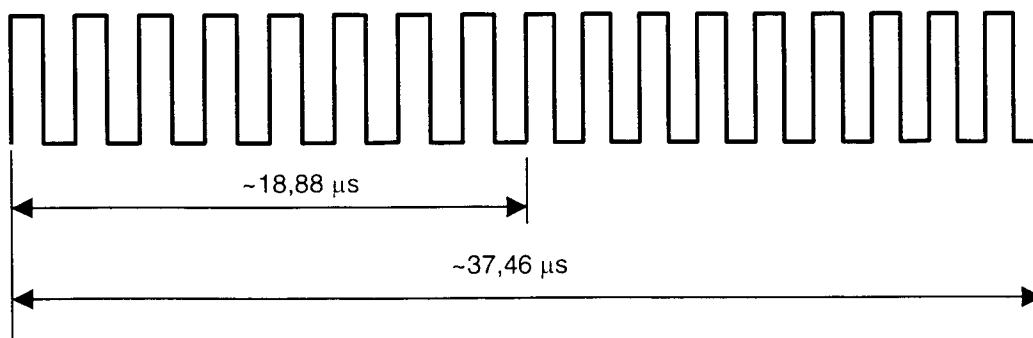

Figure 12 — Logic 0

A logic 1 starts with 9 pulses of $f_c/28$ ($\sim 484,28 \text{ kHz}$) followed by 8 pulses of $f_c/32$ ($\sim 423,75 \text{ kHz}$), see Figure 13.

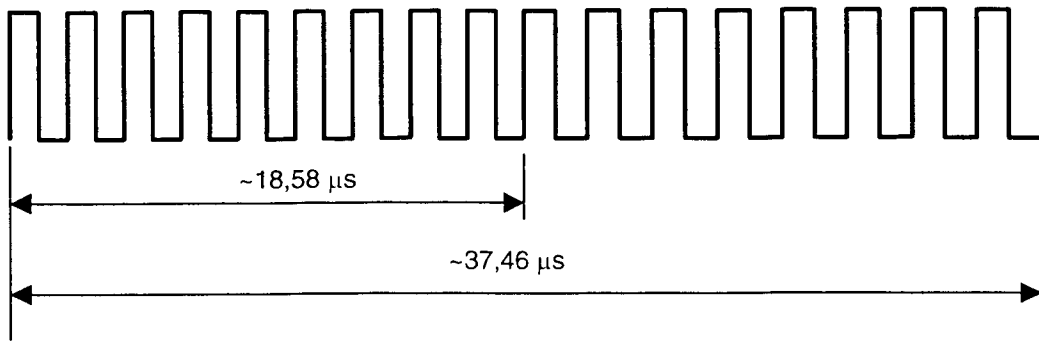

Figure 13 — Logic 1

8.5 VICC to VCD frames

Framing has been chosen for ease of synchronization and independence of protocol.

Frames are delimited by a start of frame (SOF) and an end of frame (EOF) and are implemented using code violation. Unused options are reserved for future use by the ISO/IEC.

All timings shown below refer to the high data rate from the VICC to the VCD.

For the low data rate the same subcarrier frequency or frequencies are used, in this case the number of pulses and the timing shall be multiplied by 4.

The VCD shall be ready to receive a frame from the VICC within $300 \mu\text{s}$ after having sent a frame to the VICC.

8.5.1 SOF when using one subcarrier

SOF comprises 3 parts:

- an unmodulated time of $768/f_c$ ($\sim 56,64 \mu\text{s}$).
- 24 pulses of $f_c/32$ ($\sim 423,75 \text{ kHz}$).
- a logic 1 which starts with an unmodulated time of $256/f_c$ ($\sim 18,88 \mu\text{s}$), followed by 8 pulses of $f_c/32$ ($\sim 423,75 \text{ kHz}$).

The SOF for one subcarrier is illustrated in Figure 14.

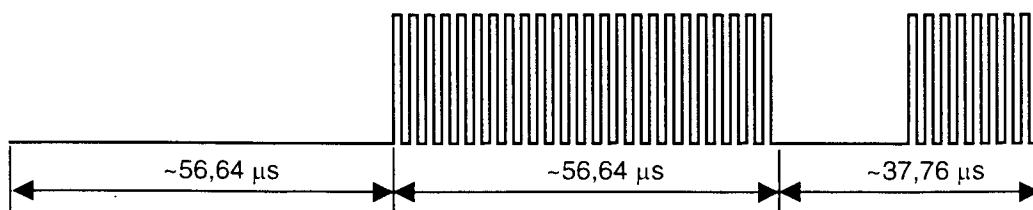

Figure 14 — Start of frame when using one subcarrier

8.5.2 SOF when using two subcarriers

SOF comprises 3 parts:

- pulses of $f_c/28$ (~484,28 kHz).
- 24 pulses of $f_c/32$ (~423,75 kHz).
- a logic 1 which starts with 9 pulses of $f_c/28$ (~484,28 kHz) followed by 8 pulses of $f_c/32$ (~423,75 kHz).

The SOF for 2 subcarriers is illustrated in Figure 15.

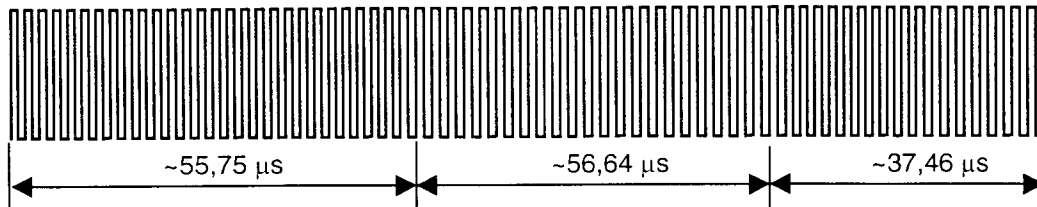

Figure 15 — Start of frame when using two subcarriers

8.5.3 EOF when using one subcarrier

EOF comprises 3 parts:

- a logic 0 which starts with 8 pulses of $f_c/32$ (~423,75 kHz), followed by an unmodulated time of $256/f_c$ (~18,88 μs).
- 24 pulses of $f_c/32$ (~423,75 kHz).
- an unmodulated time of $768/f_c$ (~56,64 μs).

The EOF for 1 subcarrier is illustrated in Figure 16.

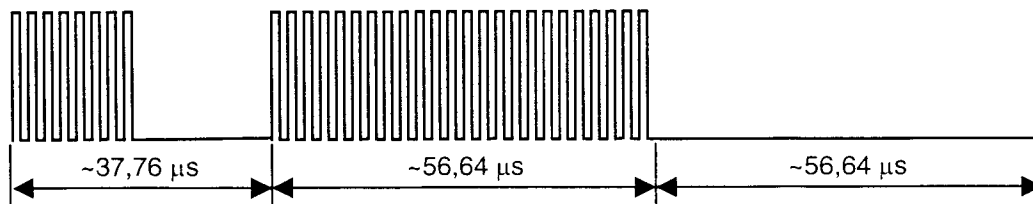

Figure 16 — End of frame when using one subcarrier

8.5.4 EOF when using two subcarriers

EOF comprises 3 parts:

- a logic 0 which starts with 8 pulses of $f_c/32$ (~423,75 kHz) followed by 9 pulses of $f_c/28$ (~484,28 kHz).
- 24 pulses of $f_c/32$ (~423,75 kHz).
- 27 pulses of $f_c/28$ (~484,28 kHz).

The EOF for 2 subcarriers is illustrated in Figure 17.

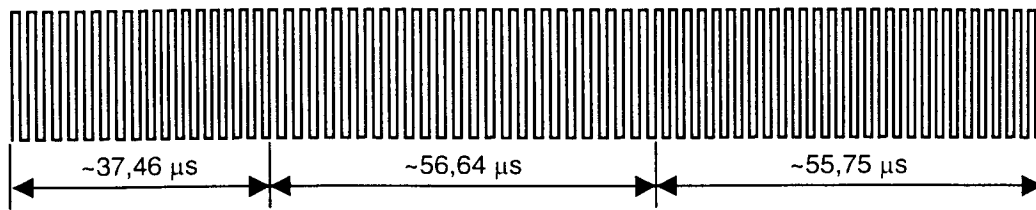

Figure 17 — End of frame when using 2 subcarriers

Annex A (informative)

Standards compatibility

This part of ISO/IEC 15693 does not preclude the addition of other existing card standards on the VICC, such as those listed as follows:

ISO/IEC 7811 (all parts), *Identification cards — Recording technique.*

ISO/IEC 7812 (all parts), *Identification cards — Identification of issuers.*

ISO/IEC 7813, *Identification cards — Financial transaction cards.*

ISO/IEC 7816 (all parts), *Identification cards — Integrated circuit(s) cards with contacts.*

ISO/IEC 10536 (all parts), *Identification cards — Contactless integrated circuit(s) cards — Close-coupled cards.*

ISO/IEC 14443 (all parts), *Identification cards — Contactless integrated circuit(s) cards — Proximity cards.*

ICS 35.240.15

Price based on 13 pages

© ISO/IEC 2000 – All rights reserved